

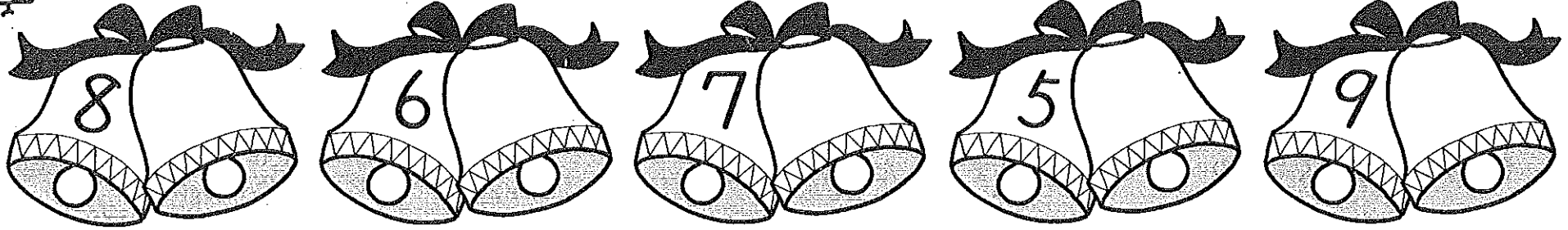

10になる かずさがし。



おさらい1.

1	2	3	4	5
3	4	9	3	8
9	7	1	6	1
8	-3	-4	2	6
-2	5	4	-7	-9

おさらい2.

1	2	3	4	5
3	8	5	7	9
7	3	-1	-4	2
4	4	4	2	4
2	-6	2	5	-7

6	7	8	9	10
5	7	8	4	1
3	1	2	9	7
4	3	-1	-5	5
-8	-5	6	2	-4

6	7	8	9	10
6	4	8	6	6
9	2	7	5	3
-3	9	-2	-4	4
8	-1	-9	-3	2





# すうじの めいろ

1・2・3・4・5から50まで じゅんばんに  
□に すうじを かこう。すすめるのは  
たて よこ だけで ななめは だめだよ。

スタート

	20	13		3	2	1
				4	5	
23			10			
	17			30		
	26			35		
		44				38
					40	

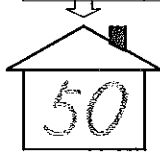

こえる  
ゴール!!

むずかしいから  
ゆっくりね。



うっきい



○にはいる かずを かこう。

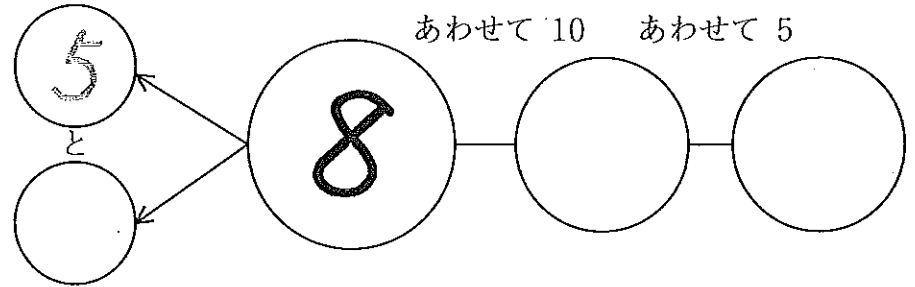
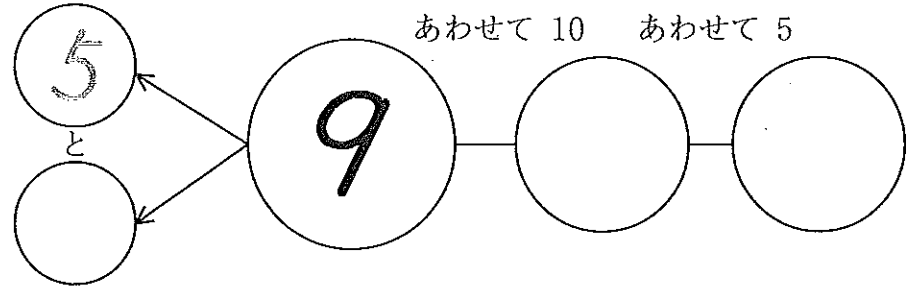
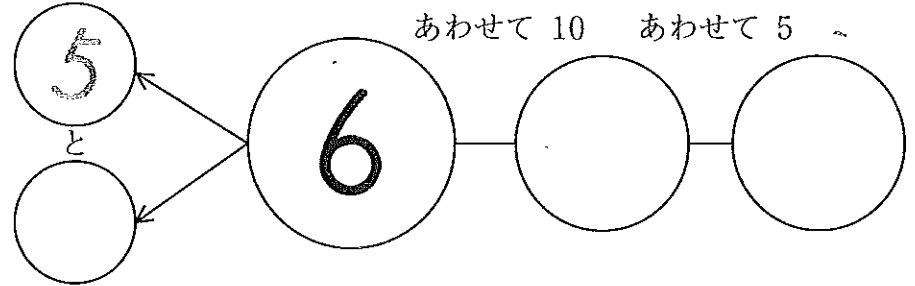
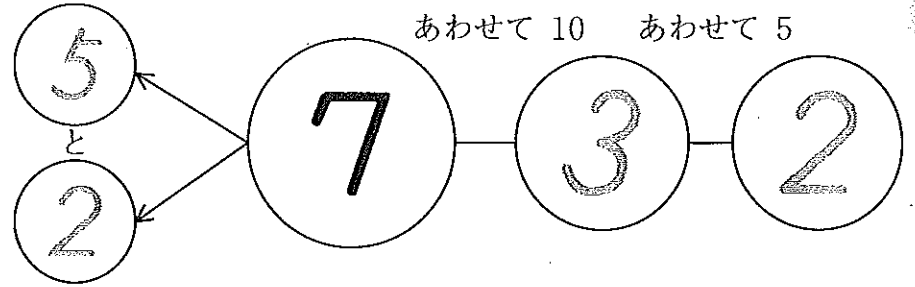

# しどう (5+9)

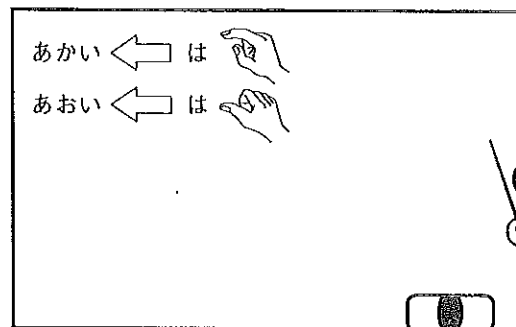
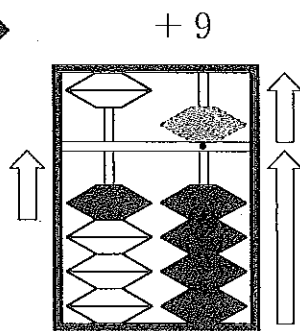
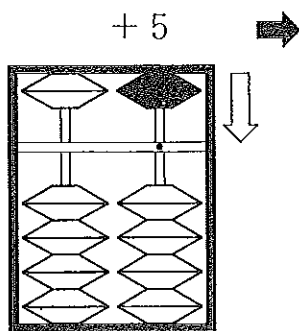
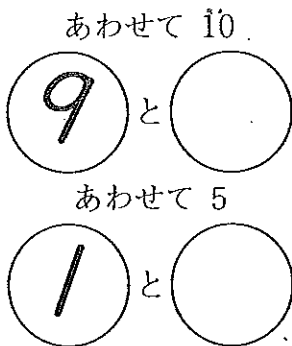
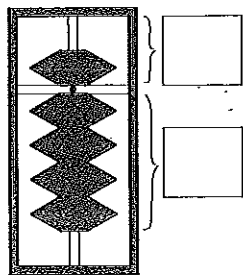

せんせい

しどう

<5+9>

1	2	3	4	5
5	5	5	5	5
9	9	9	9	9
9	5	-2	-4	-1

おけいこ 1.

<5+9>

1	2	3	4	5
5	5	5	9	5
9	9	9	6	9
8	9	7	9	6

6	7	8	9	10
6	8	5	7	9
-1	-3	9	-2	-4
9	9	-3	9	9

6	7	8	9	10
4	5	1	5	3
1	9	4	9	2
9	3	9	2	9





5になる かずさがし。

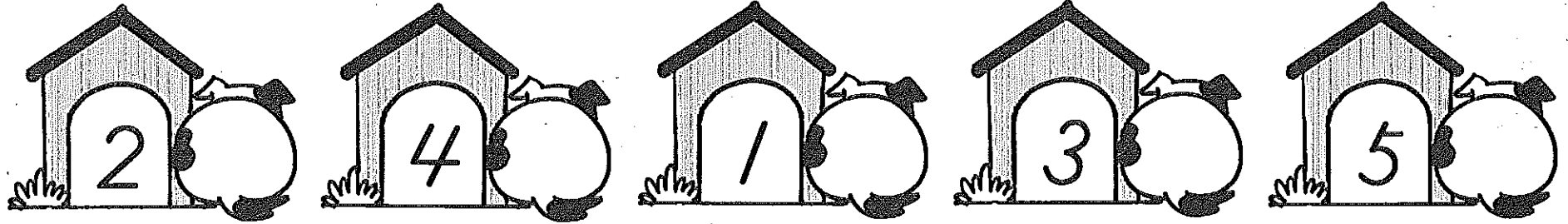

おけいこ 2.

<5+9>

1	2	3	4	5
5	5	5	5	5
9	9	9	9	9
6	7	6	-5	8
-2	-3	-1	1	-4

まとめ

<5+9>

1	2	3	4	5
7	5	7	5	6
-4	9	8	9	-3
2	7	9	2	2
9	-8	-5	-7	9

6	7	8	9	10
7	5	8	5	5
-3	9	-4	9	-1
1	1	1	2	1
9	-4	9	-3	9

6	7	8	9	10
5	3	6	5	7
9	4	-2	9	5
9	8	1	2	3
-4	9	9	4	9





# しどう (5+8)

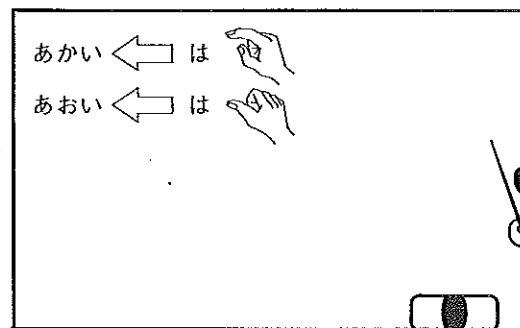
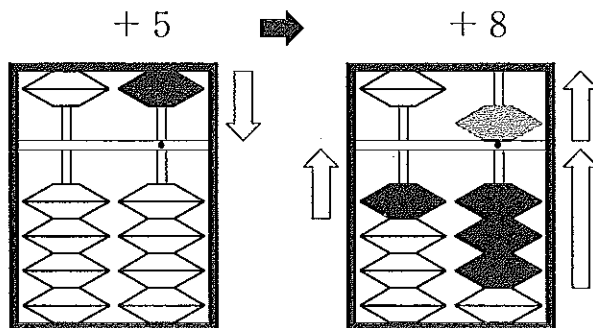
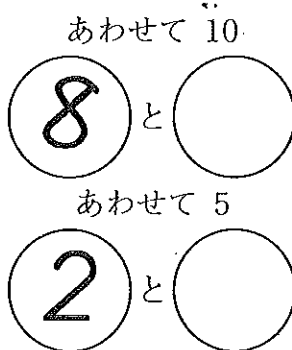
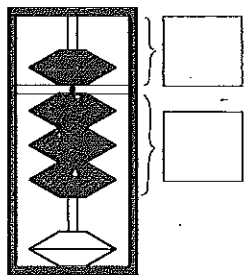

せんせい

しどう

おけいこ 1.

<5+8>

<5+8>

1	2	3	4	5
5	5	5	5	5
8	8	8	8	8
8	1	5	6	-3

1	2	3	4	5
5	6	5	6	5
8	8	8	8	8
7	9	9	6	8

6	7	8	9	10
6	9	5	7	6
8	-4	8	-2	8
-2	8	-1	8	-4

6	7	8	9	10
4	2	4	6	5
2	3	1	8	8
8	8	8	1	4





10になる かずさがし。

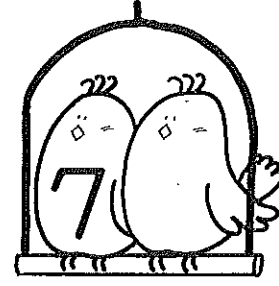
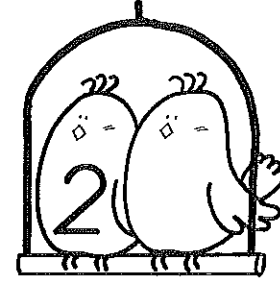
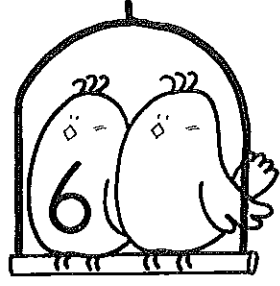
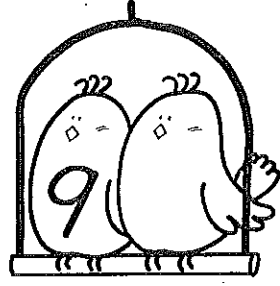
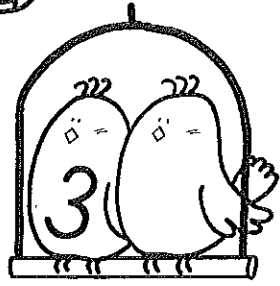

おけいこ 2.

<5+8>

1	2	3	4	5
5	6	5	6	5
8	8	8	8	8
-9	7	-4	-5	-4
6	-2	2	1	3

まとめ

<5+9>

1	2	3	4	5
5	4	7	10	5
9	1	-3	-6	9
6	9	1	1	7
-4	-5	9	9	-2

<5+8>

6	7	8	9	10
5	7	6	8	5
8	-4	8	-4	8
2	2	1	1	3
-1	8	-4	8	-2

6	7	8	9	10
5	6	6	4	6
8	-4	8	1	9
7	3	1	8	8
-5	8	-2	-4	-5



# しどう (5+7)..

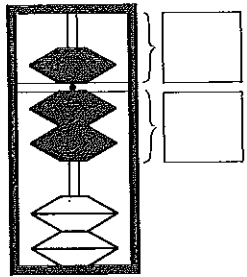

あわせて 10

7 と

あわせて 5

3 と

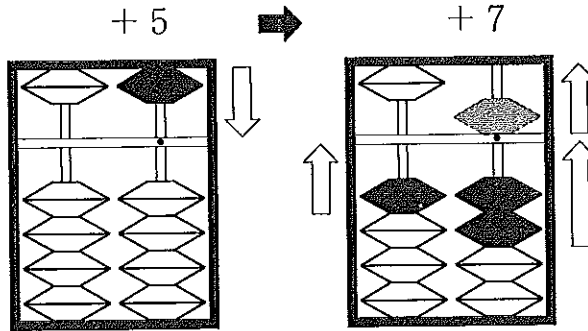

あかい ← は

あおい ← は



せんせい  
<math>(5+7)</math>

## しどう

1	2	3	4	5
5	5	6	7	6
7	7	7	7	7
7	2	5	-2	-3

6	7	8	9	10
2	9	5	6	9
5	-3	7	7	-2
7	7	6	-1	7

## おけいこ 1.

1	2	3	4	5
5	6	7	8	9
7	7	8	9	6
9	8	7	7	7

6	7	8	9	10
3	2	7	6	5
2	3	7	7	7
7	7	1	4	4



5になる かずさがし。

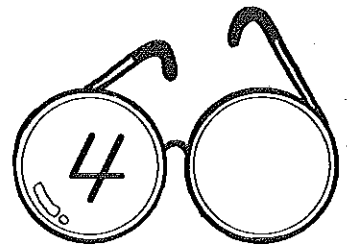
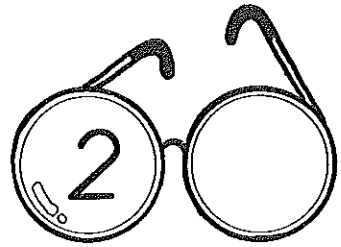
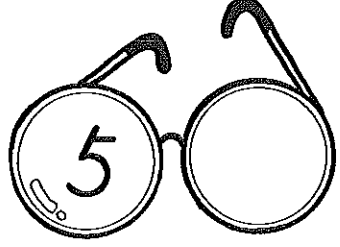
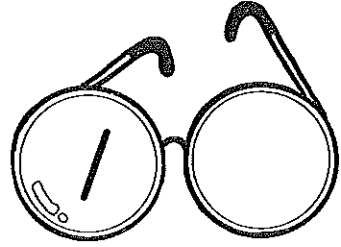
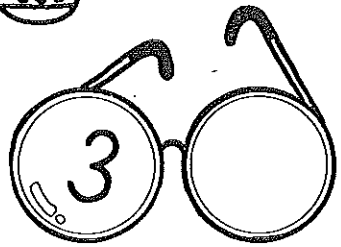

おけいこ 2.

〈5+7〉

1	2	3	4	5
5	6	5	7	6
7	7	7	7	7
8	-4	9	-5	-4
-1	1	-2	3	5

6	7	8	9	10
7	5	5	6	5
-4	7	-1	7	7
2	3	3	2	4
7	-1	7	-4	-2

まとめ

〈混合〉

1	2	3	4	5
5	4	5	5	5
9	3	9	8	-1
3	8	7	-4	2
8	9	-2	6	8

〈混合〉

6	7	8	9	10
5	6	4	8	5
8	7	2	-4	7
-4	8	7	2	-4
1	-2	-5	7	-4







しどう (5+6)

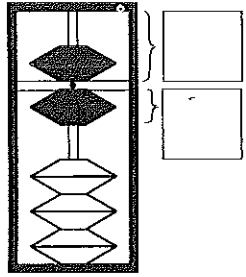

あわせて 10  
6 と ○  
あわせて 5  
4 と ○

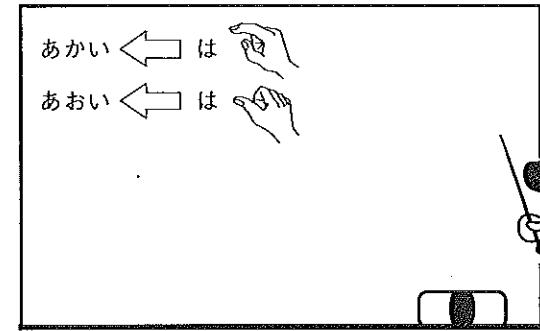
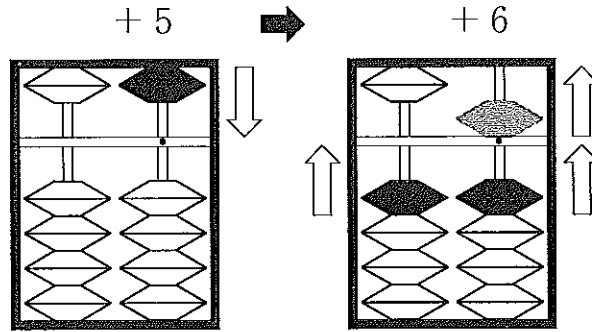

しどう

<5+6>

1	2	3	4	5
5	5	5	5	5
6	6	6	6	6
6	3	7	1	5

おけいこ 1.

<5+6>

1	2	3	4	5
5	8	8	7	9
6	7	6	9	6
9	6	7	6	6

6	7	8	9	10
2	1	7	9	8
5	7	6	-4	6
6	6	-3	6	-2

6	7	8	9	10
4	3	4	1	4
2	4	1	4	3
6	6	6	6	6





②①から④⑩の たまごが あります。ひよこに かえったのは なんばんの たまごかな。

31 36 22 40 34 30 24 32 27 33 39

35 38 23 28 21

ばんと ばんと ばんと

おけいこ 2.

<5+6>

1	2	3	4	5
5	8	7	9	7
6	6	6	8	6
9	7	-5	6	8
-7	-9	2	-5	-4

まとめ

<混合>

1	2	3	4	5
5	4	7	5	4
9	1	-4	8	8
6	9	2	-5	3
-3	-5	8	-4	7

6	7	8	9	10
8	7	5	8	5
-4	6	-3	6	-2
1	2	4	1	3
6	-1	6	-4	6

<混合>

6	7	8	9	10
6	5	8	5	9
7	-2	6	-1	4
-9	3	-5	3	3
6	7	-9	6	6





# すうじの めいろ

0から30まで じゅんばんに すうじを たどりながら すすもう。  
すすめるのは たてと よこ だけだよ。

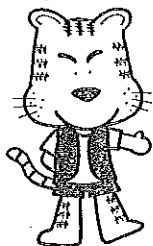

とらきち

ななめには  
すすめないよ。

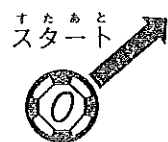

1	2	3	4	6	10	11	12	15	16	21	22	23	24	25	26
4	3	6	9	8	9	12	13	14	19	20	23	25	27	28	27
6	4	5	6	7	14	13	16	21	18	21	22	23	26	27	23
7	5	6	8	9	15	14	15	16	17	22	25	24	25	28	29

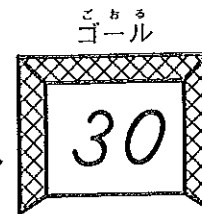

## まとめ 1.

<5 + 9>

1	2	3	4	5
5	3	2	5	1
9	2	3	9	4
4	9	9	1	9
7	-5	8	-6	7

## まとめ 2.

<5 + 7>

1	2	3	4	5
3	4	5	4	6
4	2	7	3	7
7	7	9	9	2
8	-5	4	7	-8

<5 + 8>

6	7	8	9	10
7	6	5	5	6
-4	8	8	-1	8
2	2	3	2	3
8	-3	-2	8	-4

<5 + 6>

6	7	8	9	10
8	5	7	6	5
-4	6	-4	-4	-3
1	4	2	3	4
6	-2	6	6	6



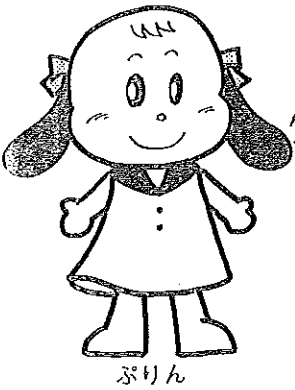

ゆっくりでいいのよ。  
おちついて  
がんばってね!!

# てすと

(1だい 10てん)

てんすう



<混合>

がつ	にち	3	4	5
1	2	3	4	5
5	6	4	7	3
9	8	3	6	2
6	3	7	7	8
3	-9	8	-2	-4

6	7	8	9	10
6	7	8	9	10
5	4	5	8	2
7	2	9	-4	4
-8	8	4	2	7
6	1	2	6	-5

よくがんばったね!!  
つぎにすすもう。



せんんにん

