

正しい指の使い方 ④

基本 1. (/ + 4) たせない 4 は 5 たして 1 を ひく。

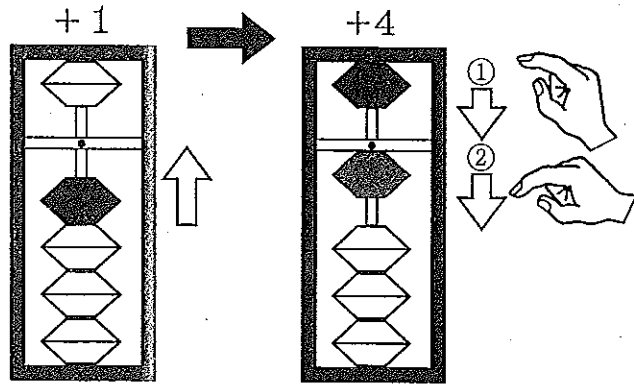

(2 + 3) たせない 3 は 5 たして 2 を ひく。

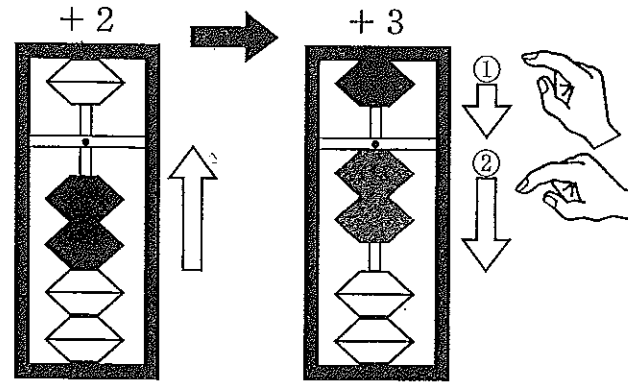

たしざんのポイント

たせない 4 は 5 たして 1 を ひく
 たせない 3 は 5 たして 2 を ひく
 たせない 2 は 5 たして 3 を ひく
 たせない 1 は 5 たして 4 を ひく

基本 2. (5 - 4) ひけない 4 は 1 たして 5 を ひく。

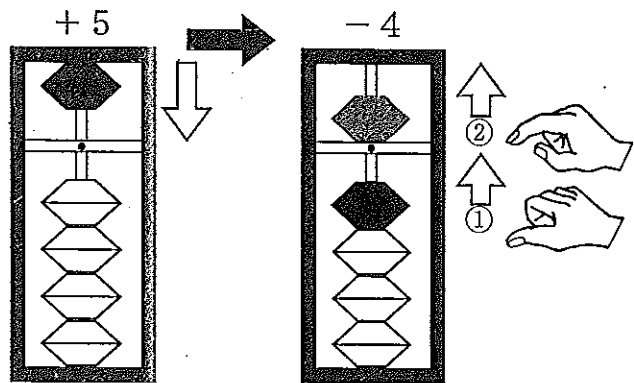

(5 - 2) ひけない 2 は 3 たして 5 を ひく。

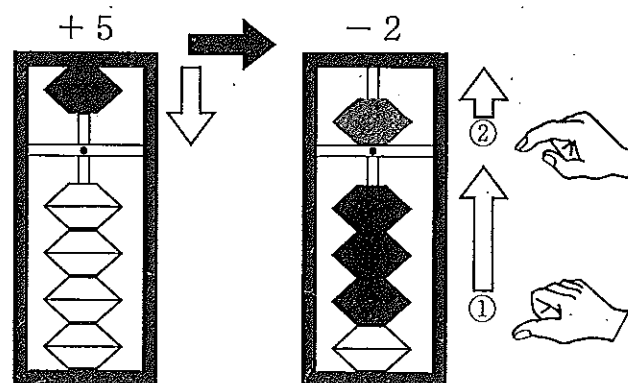

ひきざんのポイント

ひけない 4 は 1 たして 5 を ひく
 ひけない 3 は 2 たして 5 を ひく
 ひけない 2 は 3 たして 5 を ひく
 ひけない 1 は 4 たして 5 を ひく

指導される皆様へ

1. 本書では指導項目を表示しておりますので、つまずいた際には「しどう」頁に戻り反復練習をさせて下さい。
2. 本書の「しどう」項目(頁)には矢印を印刷しております。矢印は親指を使う時には青色、人差指を使う時には赤色で塗り、場合により①②③と順序を記入しご利用下さい。尚、小さな子供達には指(爪)に同色のテープを貼り指導されるのも一つの方法です。



10 になる かずさがし。

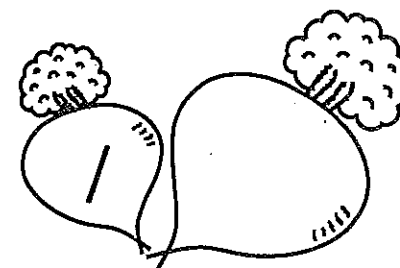
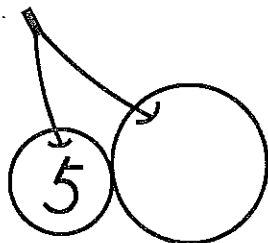
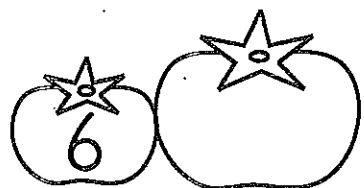

おさらい 1.

1	2	3	4	5
3	8	2	5	8
9	3	6	3	4
5	-2	7	2	-5
-8	-4	-9	-4	1

おさらい 2.

1	2	3	4	5
5	1	7	3	8
3	8	4	8	5
2	6	-9	-2	-4
-1	-7	6	-9	-6

6	7	8	9	10
6	4	7	1	9
3	8	5	8	-7
1	-3	-2	6	6
-6	-7	-1	-7	2

6	7	8	9	10
9	4	6	2	5
1	5	9	7	4
-3	7	-6	3	3
-5	-8	-5	-5	-4



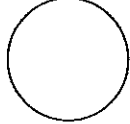

しどう (1+4)

あわせて 5

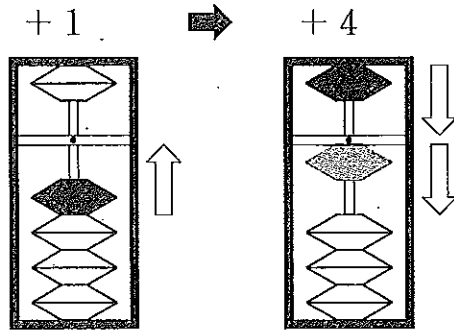
4 と 

あかい ← は 

あおい ← は 



せんせい

しどう

<1+4>

1	2	3	4	5
1	2	3	4	11
4	4	4	4	4

おけいこ 1.

<1+4>

1	2	3	4	5
2	3	4	4	7
9	8	7	6	5
3	2	1	2	1
4	4	4	4	4

6	7	8	9	10
1	2	3	7	9
1	1	1	-6	-7
4	4	4	4	4

6	7	8	9	10
7	8	8	9	1
4	3	2	1	2
3	1	3	2	8
4	4	4	4	4





5 になる かずさがし。

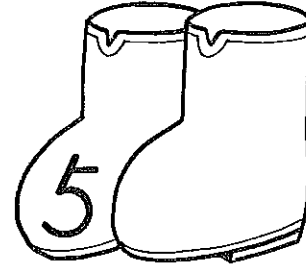
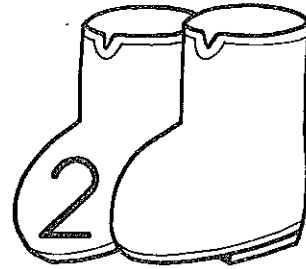
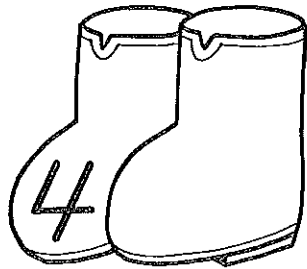
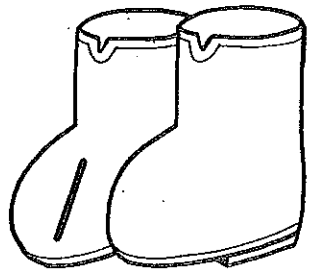
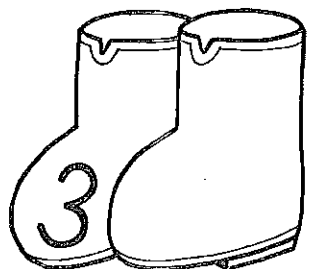

おけいこ 2.

<1+4>

1	2	3	4	5
10	12	11	10	13
-9	-8	-7	-6	-5
2	-3	-2	-3	-6
4	4	4	4	4

まとめ

<1+4>

1	2	3	4	5
7	9	9	8	9
9	1	7	3	5
-5	3	-5	2	-3
4	4	4	4	4

6	7	8	9	10
12	10	11	10	14
-4	-3	-2	-1	-5
-5	-6	-5	-7	-8
4	4	4	4	4

6	7	8	9	10
15	11	10	14	12
-6	-2	-8	-5	-4
-7	-8	2	-6	-7
4	4	4	4	4



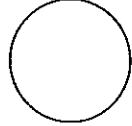

しどう (2+3)

あわせて 5

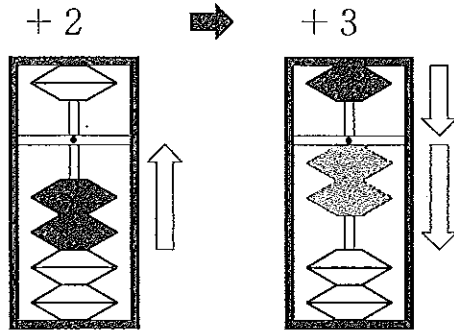
3 と 

あかい ← は 

あおい ← は 



せんせい

しどう

<2+3>

1	2	3	4	5
2	3	4	12	13
3	3	3	3	3

おけいこ 1.

<2+3>

1	2	3	4	5
1	2	4	4	7
9	8	7	6	5
4	2	1	4	1
3	3	3	3	3

6	7	8	9	10
4	8	9	8	9
-2	-5	-7	-6	-5
3	3	3	3	3

6	7	8	9	10
7	9	8	9	6
4	3	2	1	5
1	2	4	2	2
3	3	3	3	3





5 になる かずさがし。

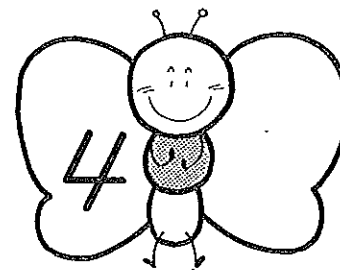
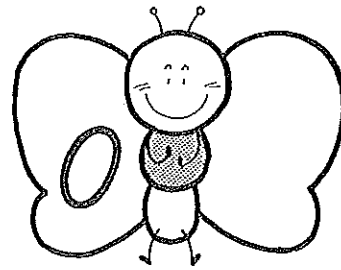
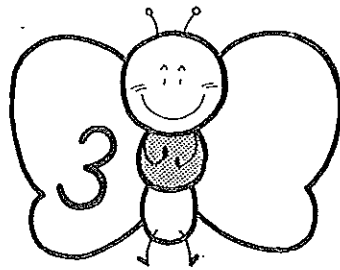
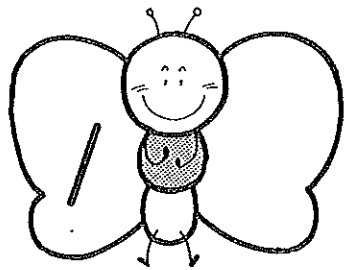
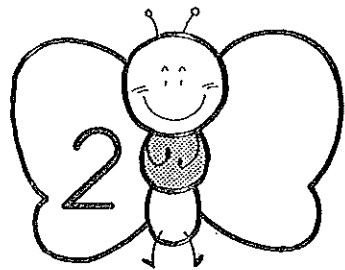

おけいこ 2.

<2+3>

1	2	3	4	5
12	15	11	15	13
-9	-8	-7	-6	-5
1	-5	-1	-5	-6
3	3	3	3	3

まとめ

<1+4>

1	2	3	4	5
9	4	7	8	1
1	7	5	3	9
3	1	2	2	3
4	4	4	4	4

6	7	8	9	10
13	12	10	10	15
-4	-3	-2	-1	-7
-5	-6	-5	-7	-6
3	3	3	3	3

<2+3>

6	7	8	9	10
13	12	10	14	15
-4	-8	-2	-5	-6
-7	-1	-6	-6	-7
3	3	3	3	3





おさんぽ めいろ。

①から⑩まで じゅんばんに すすもう。いちど とおった みちは もう とおれないよ。

す た あと
スタート



おそく
ならないでね!!

ぱっち

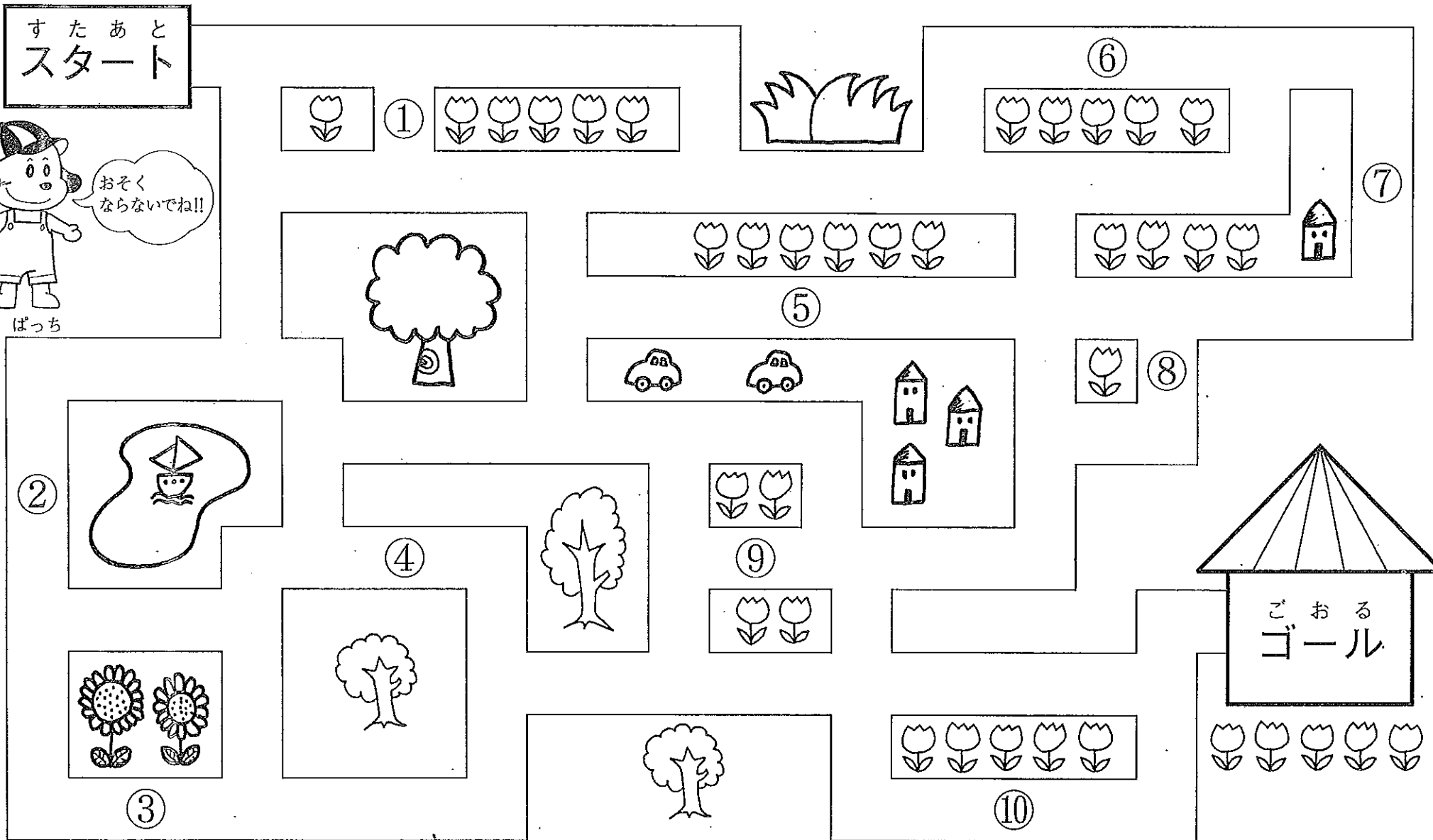







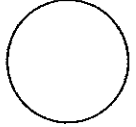

しどう (3 + 2)

あわせて 5

2 と 

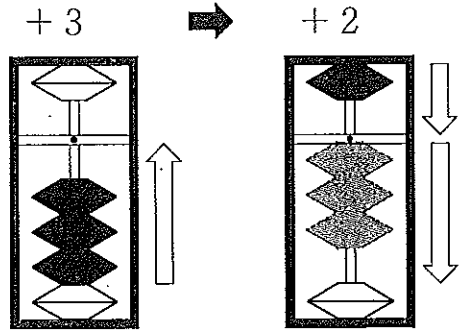

あかい ← は 

あおい ← は 



せんせい

しどう

(3 + 2)

1	2	3	4	5
3	4	13	14	2
2	2	2	2	1
				2

おけいこ 1.

(3 + 2)

1	2	3	4	5
3	4	3	4	8
9	8	7	6	5
1	2	4	3	1
2	2	2	2	2

6	7	8	9	10
3	9	8	1	2
1	-6	-5	2	2
2	2	2	2	2

6	7	8	9	10
9	8	9	9	4
4	3	2	1	7
1	2	3	4	3
2	2	2	2	2





すうじのおけいこ。

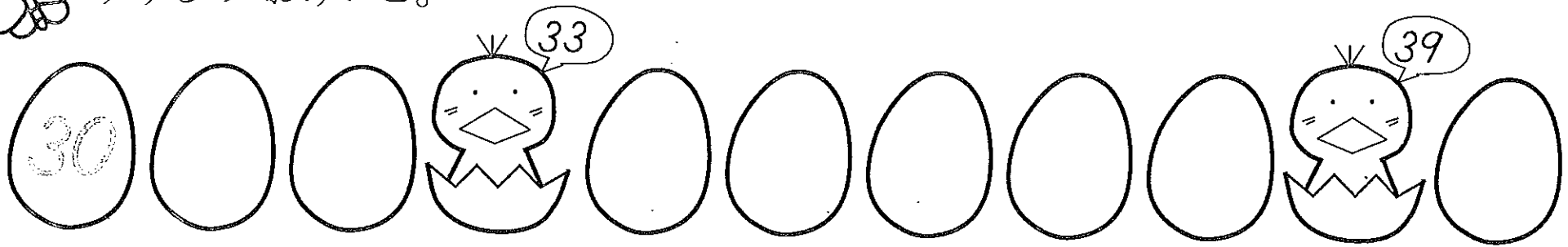

おけいこ 2.

〈3+2〉

1	2	3	4	5
17	12	16	10	14
-9	-8	-7	-6	-5
-5	-1	-5	-1	-6
2	2	2	2	2

まとめ

〈混合〉

1	2	3	4	5
8	4	9	3	4
5	7	2	9	6
1	2	3	2	3
4	4	4	3	3

6	7	8	9	10
13	12	10	10	13
-4	-3	-2	-1	2
-6	-5	-5	-6	-8
2	2	2	2	2

〈混合〉

6	7	8	9	10
10	16	14	12	12
-1	-8	-5	-3	-4
-7	-5	-5	-6	-5
3	2	2	2	2





しどう (4 + 1)

あわせて 5

と

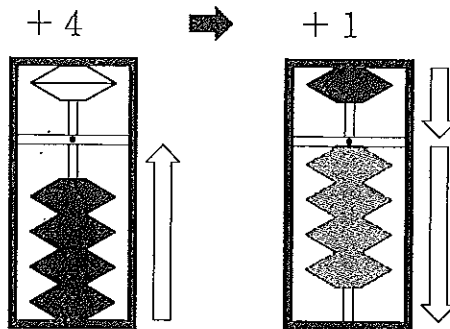

あかい ← は

あおい ← は



せんせい

しどう

<4 + 1>

1	2	3	4	5
4	/	2	3	9
	3	2	/	-5
/	/	/	/	/

おけいこ 1.

<4 + 1>

1	2	3	4	5
3	2	4	4	7
9	8	7	6	5
2	4	3	4	2
/	/	/	/	/

6	7	8	9	10
7	9	3	8	6
-6	-7	6	-5	-5
3	2	-5	/	3
/	/	/	/	/

6	7	8	9	10
8	7	9	9	6
4	3	2	/	5
2	4	3	4	3
/	/	/	/	/





じゅんばんにばんごうをつけよう。——ぼくのおいたち——

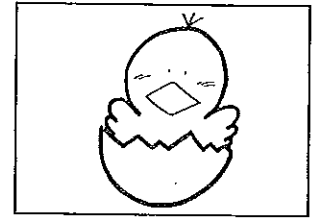
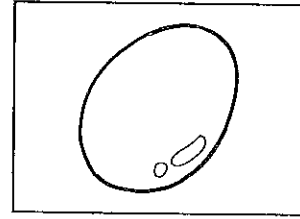
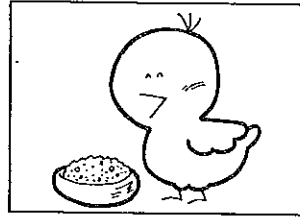
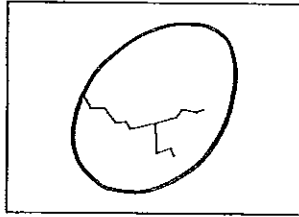
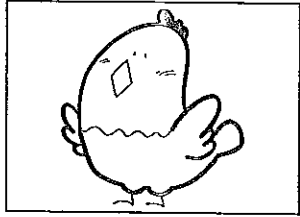

おけいこ 2.

<4+1>

1	2	3	4	5
13	12	11	10	14
-9	-8	-7	-6	-5
1	1	1	1	-5
2	4	3	1	1

まとめ

<混合>

1	2	3	4	5
3	7	9	8	9
9	5	2	3	1
2	1	1	2	4
4	4	3	3	2

6	7	8	9	10
13	12	11	10	17
-4	-3	-2	-1	-8
-5	-5	-5	-5	-5
1	1	1	1	1

<混合>

6	7	8	9	10
10	13	10	15	11
-7	-4	-8	-6	-9
1	-6	2	-5	2
2	2	1	1	1



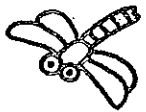

5 になる かずさがし。

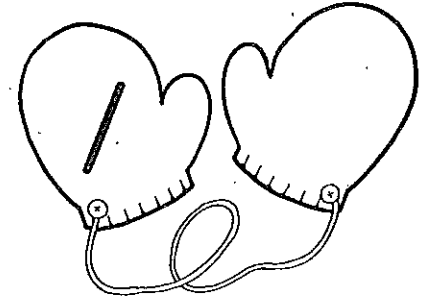
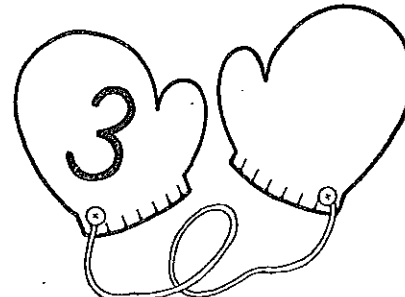
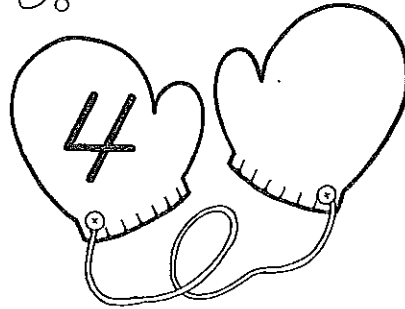
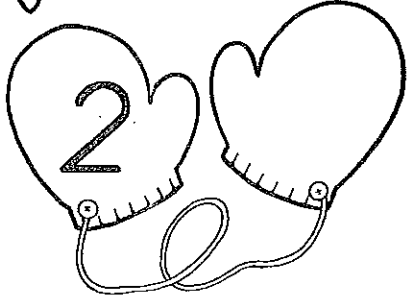

まとめ 1.

<1 + 4>

1	2	3	4	5
8	4	3	9	2
3	9	4	1	4
4	1	5	2	2
2	4	2	4	7

<2 + 3>

6	7	8	9	10
4	9	2	7	4
3	2	3	4	3
2	3	4	1	2
6	3	7	3	8

まとめ 2.

<3 + 2>

1	2	3	4	5
13	14	11	17	15
2	-5	-2	-8	-6
-5	-6	-5	-6	-5
-4	2	2	2	2

<4 + 1>

6	7	8	9	10
14	10	10	12	11
-5	-1	-7	-3	-9
-5	-5	1	-5	2
1	1	1	1	1

