

たのしい しせい

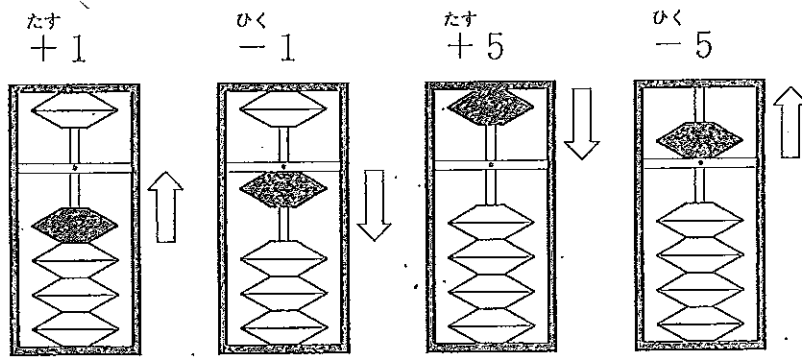

あかい ← は

あおい ← は

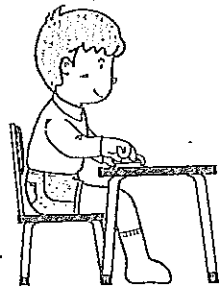
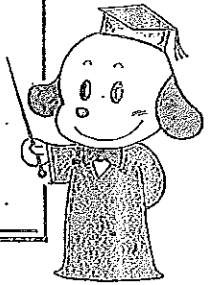

せんせい
〈+5〉

れんじゅう 1.

〈+1〉

| 1 | 2 | 3 | 4 | 5 |
|---|---|---|---|---|
| 1 | 2 | 1 | 1 | 1 |
| 1 | 1 | 3 | 1 | 2 |
| | | | | |

〈-1〉

| 6 | 7 | 8 | 9 | 10 |
|----|----|----|----|----|
| 2 | 3 | 4 | 2 | 2 |
| -1 | 1 | -3 | -1 | 2 |
| 1 | -2 | 2 | 3 | -4 |
| | | | | |

れんじゅう 2.

〈+5〉

| 1 | 2 | 3 | 4 | 5 |
|---|---|---|----|----|
| 5 | 3 | 5 | 4 | 5 |
| 1 | 5 | 2 | 5 | 3 |
| 2 | 1 | 2 | -3 | -1 |
| | | | | |

〈-5〉

| 6 | 7 | 8 | 9 | 10 |
|----|----|----|----|----|
| 5 | 5 | 1 | 5 | 5 |
| -5 | 3 | 5 | -5 | -5 |
| 1 | -5 | -5 | 4 | 5 |
| | | | | |



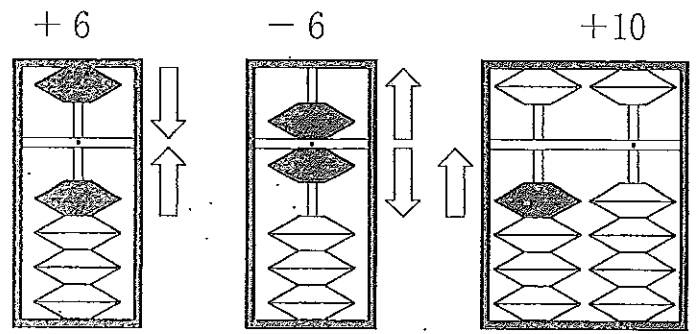

あかい ← は

あおい ← は

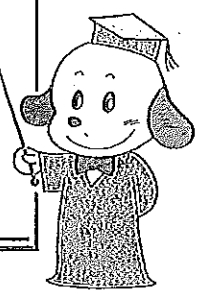

せんせい
〈混合〉

れんしゅう 1.

〈+6〉

| 1 | 2 | 3 | 4 | 5 |
|---|---|----|----|----|
| 6 | 7 | 8 | 9 | 6 |
| 2 | 1 | -3 | -4 | -5 |
| 1 | 1 | 2 | 3 | 7 |
| | | | | |

れんしゅう 2.

〈混合〉

| 1 | 2 | 3 | 4 | 5 |
|----|----|----|----|----|
| 3 | 7 | 9 | 8 | 5 |
| 5 | 2 | -8 | -5 | 4 |
| -6 | -5 | 7 | 6 | -9 |
| | | | | |

〈-6〉

| 6 | 7 | 8 | 9 | 10 |
|----|----|----|----|----|
| 6 | 8 | 9 | 2 | 9 |
| -6 | 1 | -8 | 7 | -7 |
| 8 | -7 | 5 | -9 | 6 |
| | | | | |

〈+10〉

| 6 | 7 | 8 | 9 | 10 |
|----|----|----|----|----|
| 10 | 10 | 8 | 10 | 9 |
| 1 | 3 | -6 | 9 | -8 |
| 5 | 6 | 10 | -7 | 10 |
| | | | | |



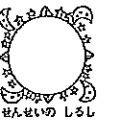

しどう (1 + 9) ^{たす}

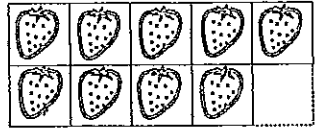

あわせて10
9 と 0

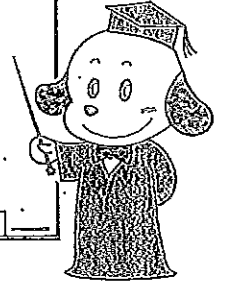
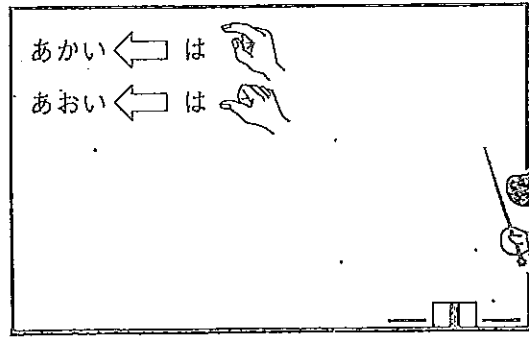
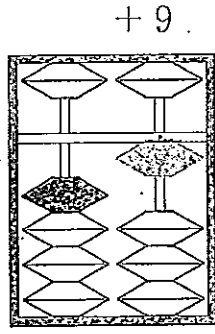
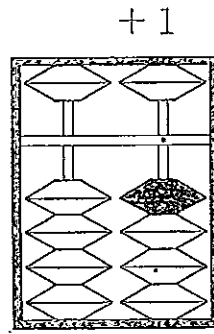

せんせい
<1+9>

しどう ..

<1+9>

| 1 | 2 | 3 | 4 | 5 |
|---|---|---|---|---|
| 1 | 2 | 3 | 4 | 6 |
| 9 | 9 | 9 | 9 | 9 |
| | | | | |

| 6 | 7 | 8 | 9 | 10 |
|---|---|----|---|----|
| 3 | 5 | 8 | 1 | 6 |
| 5 | 4 | -7 | 8 | 1 |
| 9 | 9 | 9 | 9 | 9 |
| | | | | |

おけいこ 1.

| 1 | 2 | 3 | 4 | 5 |
|---|----|---|---|---|
| 1 | 9 | 2 | 6 | 8 |
| 9 | -8 | 9 | 9 | 1 |
| 8 | 9 | 6 | 4 | 9 |
| | | | | |

| 6 | 7 | 8 | 9 | 10 |
|---|----|---|---|----|
| 5 | 4 | 3 | 5 | 7 |
| 3 | -2 | 9 | 2 | 9 |
| 9 | 9 | 6 | 9 | 1 |
| | | | | |



10になる かずさがし。

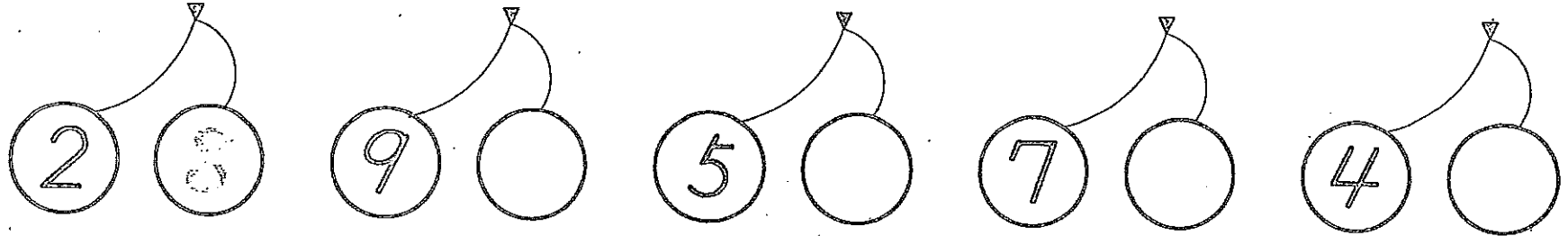

おけいこ 2.

<1+9>

| 1 | 2 | 3 | 4 | 5 |
|---|----|---|---|---|
| 4 | 8 | 1 | 6 | 5 |
| 5 | 9 | 7 | 9 | 1 |
| 9 | -2 | 9 | 3 | 9 |
| | | | | |

まとめ

<1+9>

| 1 | 2 | 3 | 4 | 5 |
|---|----|---|---|----|
| 1 | 8 | 4 | 6 | 9 |
| 6 | 9 | 9 | 2 | -3 |
| 9 | -5 | 1 | 9 | 9 |
| | | | | |

| 6 | 7 | 8 | 9 | 10 |
|---|---|----|---|----|
| 5 | 2 | 7 | 3 | 9 |
| 3 | 9 | -6 | 9 | -7 |
| 9 | 8 | 9 | 7 | 9 |
| | | | | |

| 6 | 7 | 8 | 9 | 10 |
|----|---|---|---|----|
| 3 | 5 | 2 | 7 | 8 |
| -1 | 2 | 9 | 9 | -7 |
| 9 | 9 | 7 | 1 | 9 |
| | | | | |





しどう (2 + 8) ^{たす}

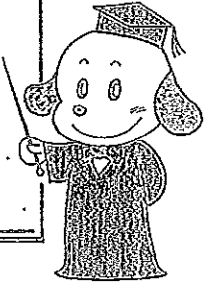
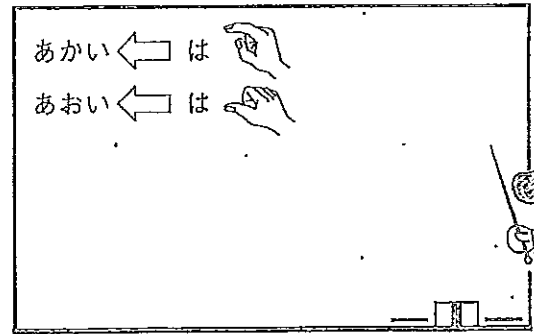
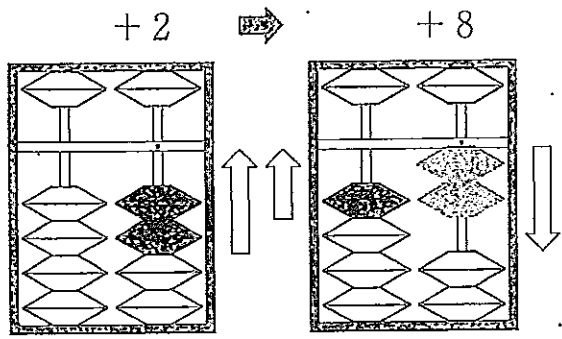
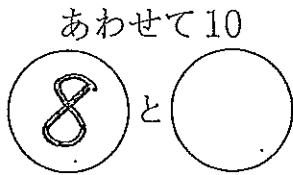
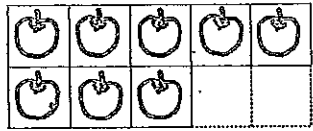

しどう ..

<2 + 8>

| 1 | 2 | 3 | 4 | 5 |
|---|---|---|---|---|
| 2 | 3 | 4 | 7 | 9 |
| 8 | 8 | 8 | 8 | 8 |
| | | | | |

おけいこ 1.

せんせい
<2 + 8>

| 1 | 2 | 3 | 4 | 5 |
|---|----|---|----|----|
| 1 | 7 | 3 | 9 | 8 |
| 7 | -5 | 5 | 8 | -6 |
| 8 | 8 | 8 | -6 | 8 |
| | | | | |

| 6 | 7 | 8 | 9 | 10 |
|---|---|---|----|----|
| 1 | 7 | 3 | 9 | 5 |
| 3 | 2 | 6 | -6 | 2 |
| 8 | 8 | 8 | 8 | 8 |
| | | | | |

| 6 | 7 | 8 | 9 | 10 |
|----|---|---|---|----|
| 8 | 6 | 2 | 4 | 9 |
| -5 | 3 | 8 | 8 | -7 |
| 8 | 8 | 5 | 1 | 8 |
| | | | | |



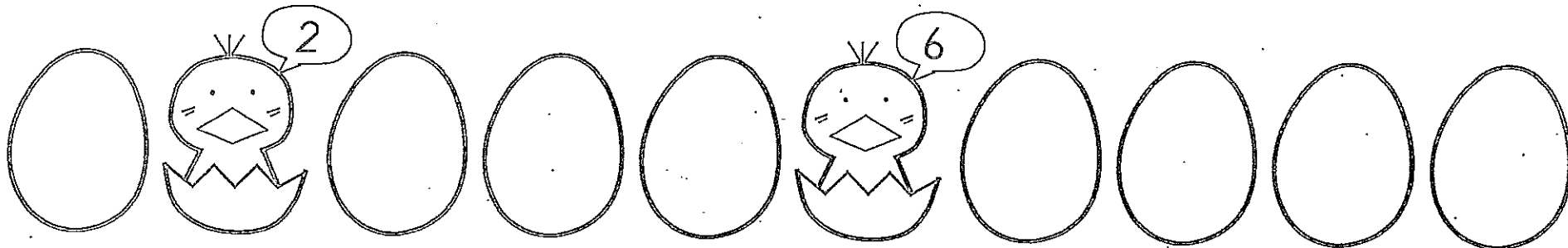

おけいこ 2.

<2+8>

| 1 | 2 | 3 | 4 | 5 |
|---|----|---|----|---|
| 4 | 8 | 1 | 9 | 5 |
| 8 | 8 | 8 | -7 | 3 |
| 5 | -6 | 8 | 8 | 8 |
| | | | | |

まとめ

<1+9>

| 1 | 2 | 3 | 4 | 5 |
|---|---|----|---|----|
| 5 | 1 | 7 | 6 | 9 |
| 2 | 3 | -6 | 2 | -5 |
| 9 | 9 | 9 | 9 | 9 |
| | | | | |

<2+8>

| 6 | 7 | 8 | 9 | 10 |
|---|---|----|---|----|
| 6 | 2 | 7 | 3 | 4 |
| 1 | 8 | -5 | 8 | -1 |
| 8 | 9 | 8 | 2 | 8 |
| | | | | |

| 6 | 7 | 8 | 9 | 10 |
|---|---|---|----|----|
| 2 | 7 | 4 | 8 | 3 |
| 2 | 1 | 5 | -1 | 6 |
| 8 | 8 | 8 | 8 | 8 |
| | | | | |





しどう (3 + 7) ^{たす}

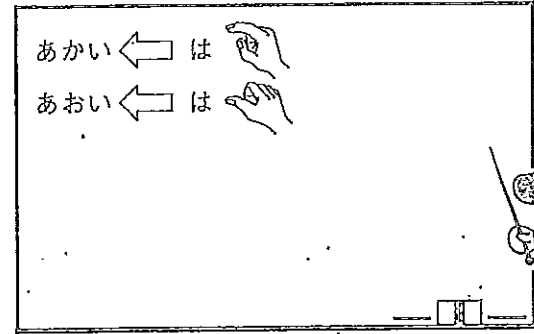
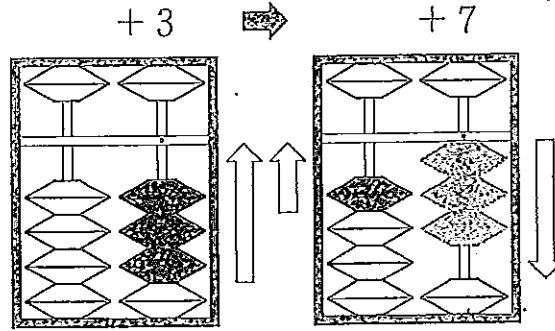
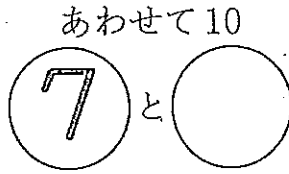
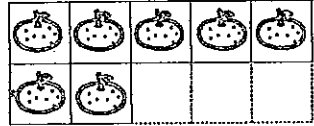

せんせい
<3 + 7>

しどう...

<3 + 7>

| 1 | 2 | 3 | 4 | 5 |
|---|---|---|---|---|
| 3 | 4 | 8 | 9 | 3 |
| 7 | 7 | 7 | 7 | 5 |
| 7 | 7 | 7 | 7 | 7 |
| | | | | |

| 6 | 7 | 8 | 9 | 10 |
|---|---|---|---|----|
| 2 | 2 | 5 | 6 | 7 |
| 1 | 2 | 3 | 3 | 1 |
| 7 | 7 | 7 | 7 | 7 |
| | | | | |

おけいこ 1.

<3 + 7>

| 1 | 2 | 3 | 4 | 5 |
|---|----|---|---|----|
| 3 | 9 | 8 | 2 | 9 |
| 7 | -5 | 7 | 6 | -6 |
| 2 | 7 | 4 | 7 | 7 |
| | | | | |

| 6 | 7 | 8 | 9 | 10 |
|---|---|----|---|----|
| 4 | 3 | 8 | 1 | 3 |
| 7 | 1 | -5 | 7 | 7 |
| 5 | 7 | 7 | 7 | 3 |
| | | | | |



🚗 なんばんめ。

まえ

は まえから ばんめ。 は うしろから ばんめ。

おけいこ 2.

<3+7>

| 1 | 2 | 3 | 4 | 5 |
|---|---|----|---|----|
| 5 | 2 | 8 | 1 | 9 |
| 4 | 6 | 7 | 7 | 7 |
| 7 | 7 | -5 | 7 | -6 |
| | | | | |

| 6 | 7 | 8 | 9 | 10 |
|---|---|---|---|----|
| 4 | 7 | 6 | 3 | 8 |
| 7 | 1 | 3 | 7 | 7 |
| 5 | 7 | 7 | 2 | 4 |
| | | | | |

まとめ

<混合>

| 1 | 2 | 3 | 4 | 5 |
|---|---|----|---|----|
| 5 | 3 | 8 | 2 | 9 |
| 1 | 6 | -7 | 5 | -6 |
| 9 | 9 | 9 | 8 | 8 |
| | | | | |

<混合>

| 6 | 7 | 8 | 9 | 10 |
|---|---|----|---|----|
| 7 | 1 | 9 | 4 | 8 |
| 1 | 2 | -1 | 5 | -5 |
| 8 | 7 | 7 | 7 | 7 |
| | | | | |





しどう (4 + 6) ^{たす}

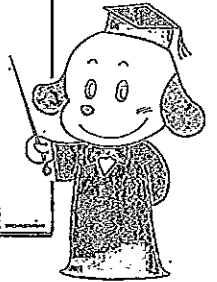
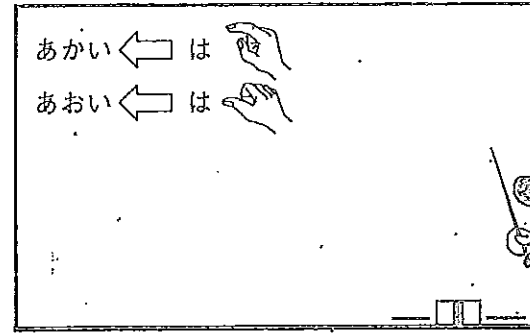
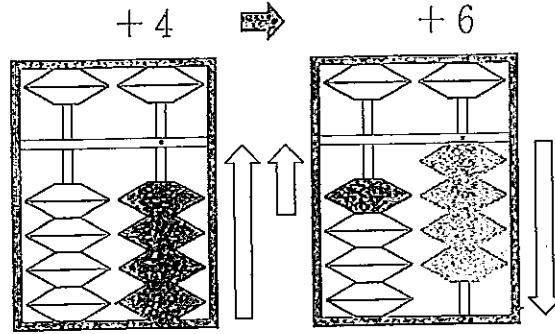
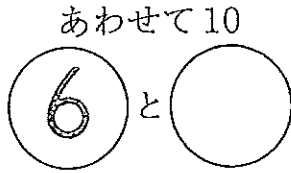

せんせい
<4 + 6>

しどう

<4 + 6>

| 1 | 2 | 3 | 4 | 5 |
|---|---|---|---|---|
| 4 | 9 | 2 | 3 | 5 |
| 6 | 6 | 2 | 1 | 4 |
| 6 | 6 | 6 | 6 | 6 |

おけいこ 1.

| 1 | 2 | 3 | 4 | 5 |
|---|---|---|---|---|
| 3 | 7 | 9 | 6 | 1 |
| 6 | 2 | 6 | 3 | 3 |
| 6 | 6 | 1 | 6 | 6 |

| 6 | 7 | 8 | 9 | 10 |
|---|---|----|---|----|
| 9 | 4 | 9 | 4 | 1 |
| 6 | 5 | -5 | 6 | 8 |
| 3 | 6 | 6 | 7 | 6 |

| 6 | 7 | 8 | 9 | 10 |
|---|----|---|---|----|
| 4 | 9 | 8 | 4 | 2 |
| 6 | 6 | 1 | 6 | 7 |
| 8 | -5 | 6 | 3 | 6 |

🚗 10になる かずさがし。

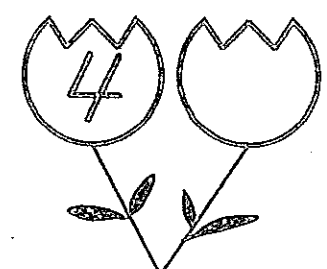
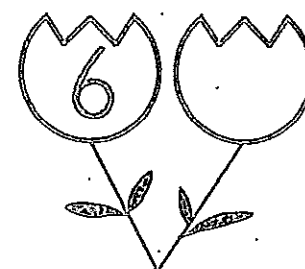
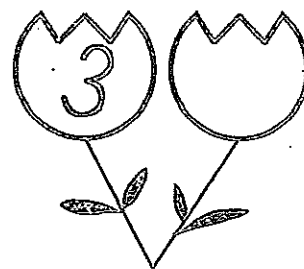
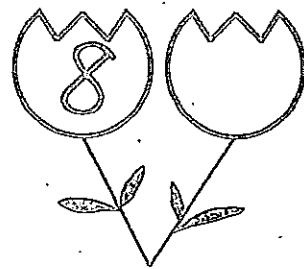
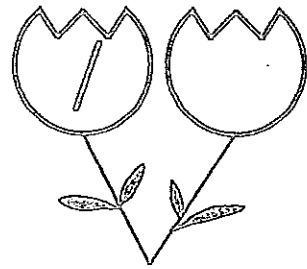

おけいこ 2.

<4+6>

| 1 | 2 | 3 | 4 | 5 |
|---|---|---|---|---|
| 2 | 9 | 4 | 7 | 3 |
| 2 | 6 | 6 | 2 | 1 |
| 6 | 4 | 5 | 6 | 6 |
| | | | | |

まとめ

<混合>

| 1 | 2 | 3 | 4 | 5 |
|---|---|---|----|---|
| 5 | 6 | 1 | 9 | 3 |
| 4 | 1 | 6 | -1 | 6 |
| 9 | 9 | 8 | 8 | 7 |
| | | | | |

| 6 | 7 | 8 | 9 | 10 |
|---|---|---|---|----|
| 5 | 1 | 8 | 6 | 9 |
| 4 | 3 | 1 | 3 | 6 |
| 6 | 6 | 6 | 6 | 2 |
| | | | | |

<混合>

| 6 | 7 | 8 | 9 | 10 |
|---|----|---|---|----|
| 7 | 9 | 2 | 4 | 1 |
| 2 | -5 | 7 | 5 | 8 |
| 7 | 6 | 6 | 6 | 6 |
| | | | | |





🚢 10になる
かずさがし。

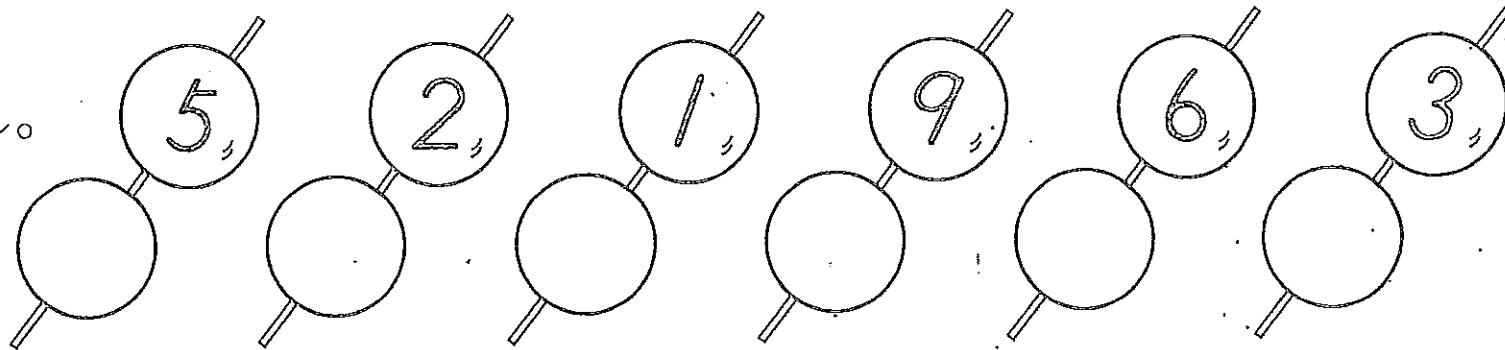

まとめ1.

<1+9>

| 1 | 2 | 3 | 4 | 5 |
|---|---|---|---|---|
| 1 | 8 | 5 | 1 | 6 |
| 9 | 1 | 4 | 7 | 9 |
| 3 | 9 | 9 | 9 | 4 |
| | | | | |

まとめ2.

<3+7>

| 1 | 2 | 3 | 4 | 5 |
|---|---|---|---|---|
| 3 | 8 | 2 | 8 | 4 |
| 5 | 1 | 1 | 7 | 7 |
| 7 | 7 | 7 | 3 | 8 |
| | | | | |

<2+8>

| 6 | 7 | 8 | 9 | 10 |
|---|---|---|---|----|
| 2 | 9 | 3 | 4 | 1 |
| 8 | 8 | 5 | 8 | 8 |
| 6 | 2 | 8 | 7 | 8 |
| | | | | |

<4+6>

| 6 | 7 | 8 | 9 | 10 |
|---|---|---|---|----|
| 4 | 9 | 5 | 8 | 9 |
| 6 | 6 | 4 | 1 | 6 |
| 3 | 4 | 6 | 6 | 2 |
| | | | | |



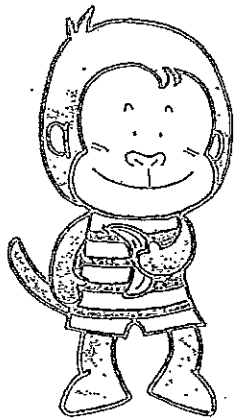

おちついて
がんばってね!

てすと

(1だい 10てん)

| |
|------|
| てんすう |
| |



うつきい

がつ

にち

<混合>

| 1 | 2 | 3 | 4 | 5 |
|----|---|---|---|----|
| 6 | 4 | 5 | 1 | 9 |
| 3 | 6 | 4 | 3 | 9 |
| -5 | 3 | 7 | 5 | 1 |
| 9 | 5 | 3 | 8 | -9 |
| | | | | |

| 6 | 7 | 8 | 9 | 10 |
|---|---|----|----|----|
| 7 | 2 | 1 | 3 | 8 |
| 2 | 2 | 9 | 8 | 7 |
| 6 | 7 | 8 | 7 | -5 |
| 4 | 5 | -7 | -5 | 8 |
| | | | | |

やったね!!
つぎにすすもう



せんにな

